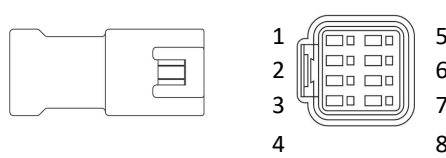
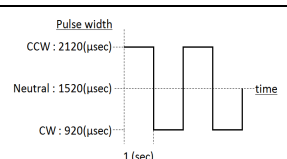

AJ9DA52/54(Speed Type) Technical Specification

Update Number

200525-04

Item		Specification				Remark		
1	Communication Interface	PWM				Signal Voltage:V	HIGH : min. 3.0V max. Vcc	
							LOW : min. 0.0V max. 0.45V	
						Frame Rate:T	3.0~30ms (Default 14.25ms)	
						CW/Center/CCW:Td	920/1520/2120μs (Resolution recommends less than 1μs.)	
		S.BUS				Futaba Serial Protocol (Please ask us for more information.)		
		RS485				Command control (Half-duplex communication,Baud Rate 9.6~460.8kbps) (Please ask us for more information.)		
2	Rated Voltage	24V DC				-		
3	Operating Voltage	20~30V DC				-		
4	Standby Current	≤ 60mA				at 24V		
5	Consumption Current*	LL	Me	UL	unit	at 24V , No-Load		
		60	120	180	mA	LL : Low Limit Me : Medium Value UL : Upper Limit		
6	Max. Torque*	LL	Me	UL	unit	at 24V		
		61.0	87.0	113.0	kgf-cm			
		5.98	8.53	11.08	N-m			
		847.1	1208.2	1569.3	ozf-in			
7	Rated Torque*	LL	Me	UL	unit	at 24V		
		12.2	17.4	22.6	kgf-cm	20% of Max. Torque		
		1.20	1.71	2.22	N-m			
		169.4	241.6	313.9	ozf-in			
8	No Load Speed*	LL	Me	UL	unit	at 24V		
		0.12	0.16	0.20	sec/60°			
		300.0	375.0	500.0	°/sec			
		50.0	62.5	83.3	rpm			
9	Default Travel Angle	CW 60° (920μs) , CCW 60° (2120μs)				-		
10	Max Travel Angle	CW 90° (920μs) , CCW 90° (2120μs)				Programing tool (CIU-2 or CIU-3,S-Link) required.		
11	BackLash*	≤ 0.5°				-		
12	Operating Temperature Range	-30~+70°C (-22~158°F)				-		
13	Storage Temperature Range	-40~+80°C (-40~176°F)				-		
14	IP Rating	IP67**				waterproof to 1m depth for 30min		
15	Outer Dimension	2.53 x 1.34 x 2.90 inch (64.2 x 34.0 x 73.7mm)				-		
16	Weight	11.89oz (337g) 12.52oz (355g) / Receptacle Type				-		
17	Case Material	Upper : AL / Middle : AL / Bottom : AL				-		
18	Gear Set Material	1st,2nd,3rd,4th(Final) : Metal				-		
19	Cable	Shielded Cable				Cable Length : 15.75 inch (400mm)		
20	Connector	Manufacture	J.S.T. Mfg. Co., Ltd					
		Type	08T-JWPF-VSLE-D					
		Mating	08R-JWPF-VSLE-D etc.					
		Pin Assignment	1	Brown	Position Feedback+			
			2	Yellow	Position Feedback-			
			3	Green	RS485 A(D+)			
			4	Blue	RS485 B(D-)			
			5	white	PWM / S.BUS			
6	Red		Battery(+)					
7	Black		Battery(-)					
8	Gray	Case Shield Line						
21	MTTF	310h (at 24V)				Test Condition • Load : 20% of Max. Torque • Operating Condition : 0.5Hz sweep (±60°) • Input Pulse : PWM 		
22	Vibration Resistance *	Operating time ≥ 20h (at 24V)				Test Condition Frequency range : 11 to 500Hz Sweep Rate : 15 min / single-sweep Acceleration : 10G (98m/s ²) Vibration axis : X , Y , Z		

* Initial Performance Data at 23±5°C

** At initial state.See next page for application range.

All Specifications are subject to change without prior notice.

● Outer Dimension

AJ9DA52

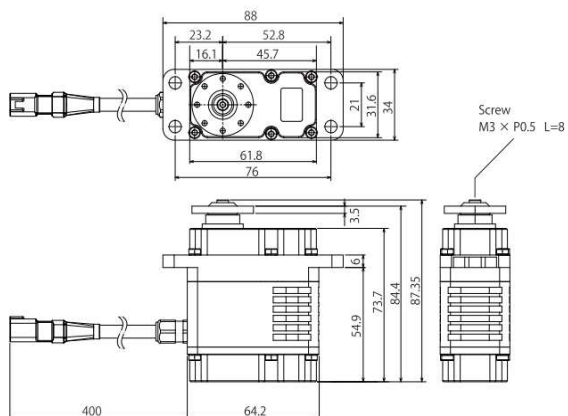

AJ9DA54(ReceptacleType)

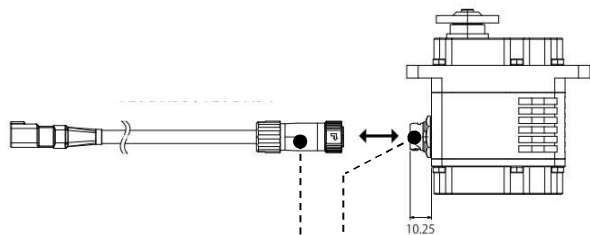

HIROSE ELECTRIC CO., LTD.
LF10WBP-12S

HIROSE ELECTRIC CO., LTD.
LF10WBRB-12P

(Unit mm)

● Position Feedback

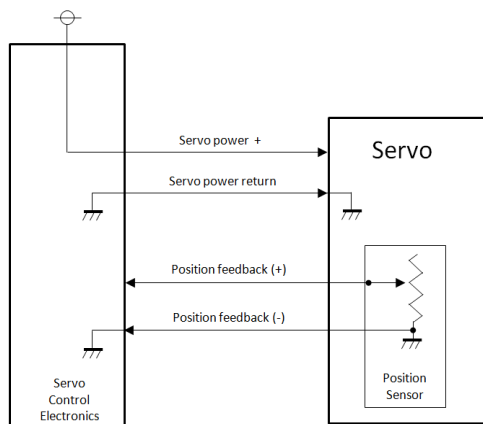

● Water Resistance

AJ9DA is comly with IP64 within the application range in figure 1.

It is possible to comply with IP67 in case of the application range in figure 2.

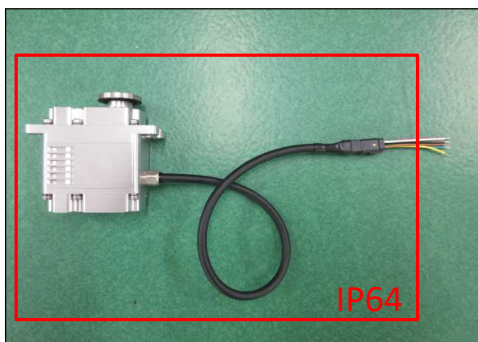

Figure 1

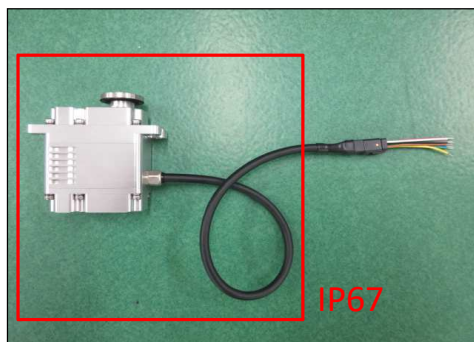

Figure 2